



INDUCTIVE SENSORS

Ø 18

10 ÷ 30 Vdc - 3 WIRES NPN OR PNP OUTPUT

- 5 mm to 8 mm operating distance - shielded, unshielded
- Short housing models
- Cable or M12 connector models
- Output status LED

IS Series



TECHNICAL DATA

	SHIELDED	UNSHIELDED
OPERATING DISTANCE (Sn)	5 mm	8 mm
POWER SUPPLY	10 ÷ 30 Vdc (-15 / +10%)	
RIPPLE	≤ 10%	
HYSTERESIS	< 10%	
OUTPUT CURRENT	200 mA max.	
CONSUMPTION	< 10 mA @ 24 Vdc	
SATURATION VOLTAGE	< 1.8 V (I = 100 mA)	
INDICATORS	Yellow LED	
SWITCHING FREQUENCY	1000 Hz	
DELAY AT POWER ON	≤ 50 ms	
REPEATABILITY	≤ 3%	
SHORT CIRCUIT PROTECTION	Present (self-resetting)	
PROTECTIONS CIRCUIT	Against polarity reversal - inductive loads	
OPERATING TEMPERATURE	- 25 ÷ +60 °C	
MECHANICAL PROTECTION	IP67	
CONNECTIONS	2 m cable (3 x 0.25 mm ²)	
HOUSING MATERIAL	Nickel-plated brass	
WEIGHT	145 g cable version	
	95 g M12 connector cable	

⁽⁴⁾ Device marking II 3D IP67 T6X.

CONNECTIONS

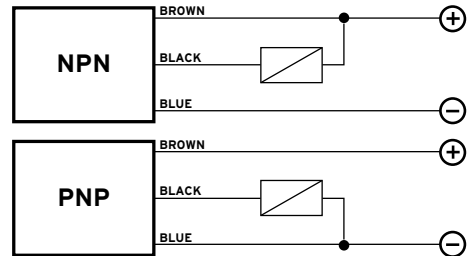

M12 CONNECTOR

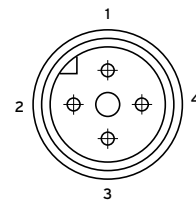

View of quadripole male connector

CONFIGURATION

Outputs	PIN numbers			
	1	2	3	4
(NO or NC)	+		-	NO/NC

DIMENSIONS (mm)

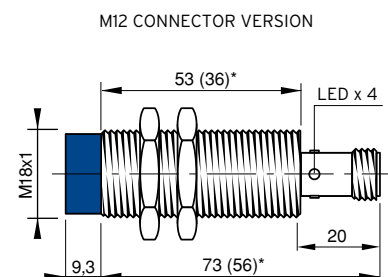
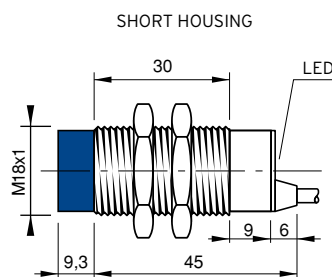
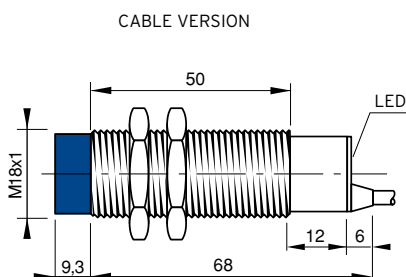

(* The dimensions in brackets refer to short housing models
Note: the front part in blue is valid only for unshielded models



MODEL SELECTION TABLE

DIAMETER	CONSTRUCTION	OUTPUT	CONNECTION
04 = 4 mm	A= shielded standard housing	1 = 10-30 Vdc PNP NO	02 = 500 mm CABLE
05 = 5 mm	B= shielded short housing	2 = 10-30 Vdc PNP NC	03 = 2 m CABLE
08 = 8 mm	C= unshielded standard housing	3 = 10-30 Vdc NPN NO	S1 = M8 CONN.
12 = 12 mm	D= unshielded short housing	4 = 10-30 Vdc NPN NC	S2 = M12 CONN.
18 = 18 mm	E= shielded standard housing, double operating distance	5 = 10-30 Vdc PNP NO-NC	
30 = 30 mm	F= unshielded standard housing, double operating distance	6 = 10-30 Vdc NPN NO-NC	
	G= shielded short housing, double operating distance	7 = 24-230 Vac - 2 wires NO	
	H= unshielded short housing, double operating distance	8 = 24-230 Vac - 2 wires NC	
	I= shielded standard metal housing	9 = 10-30 Vac - 2 wires NO-NC	
	L= unshielded standard metal housing	0 = 12-30 Vac - 4 wires	

PRODUCT TABLE

DESCRIPTION	CONNECTION	SHIELDED	HOUSING	ORDER CODE
IS-18-A1-03	2 m CABLE	yes	standard	95B061340
IS-18-A1-S2	M12 CONNECTOR	yes	standard	95B061350
IS-18-A2-03	2 m CABLE	yes	standard	95B061360
IS-18-A2-S2	M12 CONNECTOR	yes	standard	95B061370
IS-18-A3-03	2 m CABLE	yes	standard	95B061300
IS-18-A3-S2	M12 CONNECTOR	yes	standard	95B061310
IS-18-A4-03	2 m CABLE	yes	standard	95B061320
IS-18-A4-S2	M12 CONNECTOR	yes	standard	95B061330
IS-18-B1-03	2 m CABLE	yes	short	95B062140
IS-18-B1-S2	M12 CONNECTOR	yes	short	95B062150
IS-18-B2-03	2 m CABLE	yes	short	95B062160
IS-18-B2-S2	M12 CONNECTOR	yes	short	95B062170
IS-18-B3-03	2 m CABLE	yes	short	95B062100
IS-18-B3-S2	M12 CONNECTOR	yes	short	95B062110
IS-18-B4-03	2 m CABLE	yes	short	95B062120
IS-18-B4-S2	M12 CONNECTOR	yes	short	95B062130
IS-18-C1-03	2 m CABLE	no	standard	95B061740
IS-18-C1-S2	M12 CONNECTOR	no	standard	95B061750
IS-18-C2-03	2 m CABLE	no	standard	95B061760
IS-18-C2-S2	M12 CONNECTOR	no	standard	95B061770
IS-18-C3-03	2 m CABLE	no	standard	95B061700
IS-18-C3-S2	M12 CONNECTOR	no	standard	95B061710
IS-18-C4-03	2 m CABLE	no	standard	95B061720
IS-18-C4-S2	M12 CONNECTOR	no	standard	95B061730
IS-18-D1-03	2 m CABLE	no	short	95B062540
IS-18-D1-S2	M12 CONNECTOR	no	short	95B062550
IS-18-D2-03	2 m CABLE	no	short	95B062560
IS-18-D2-S2	M12 CONNECTOR	no	short	95B062570
IS-18-D3-03	2 m CABLE	no	short	95B062500
IS-18-D3-S2	M12 CONNECTOR	no	short	95B062510
IS-18-D4-03	2 m CABLE	no	short	95B062520
IS-18-D4-S2	M12 CONNECTOR	no	short	95B062530



INDUCTIVE SENSORS

Ø 18 DOUBLE OPERATING DISTANCE 10÷30 Vdc - 3 WIRES NPN OR PNP OUTPUT

- 8 mm to 14 mm operating distance - shielded, unshielded
- Short housing models
- Cable or M12 connector models
- Output status LED

IS Series



TECHNICAL DATA

	SHIELDED	UNSHIELDED
OPERATING DISTANCE (Sn)	8 mm	14 mm
POWER SUPPLY	10 ÷ 30 Vdc (-15 / +10%)	
RIPPLE	≤ 10%	
HYSTERESIS	< 10%	
OUTPUT CURRENT	200 mA max.	
CONSUMPTION	< 10 mA @ 24 Vdc	
SATURATION VOLTAGE	< 1.2 V (I = 100 mA)	
INDICATORS	Yellow LED	
SWITCHING FREQUENCY	400 Hz	
DELAY AT POWER ON	≤ 75 ms	
REPEATABILITY	≤ 3%	
SHORT CIRCUIT PROTECTION	Present (self-resetting)	
PROTECTIONS CIRCUIT	Against polarity reversal - inductive loads	
OPERATING TEMPERATURE	- 25 ÷ +70 °C	
MECHANICAL PROTECTION	IP67	
CONNECTIONS	2 m cable (3 x 0.25 mm ²)	
HOUSING MATERIAL	Nickel-plated brass	
WEIGHT	145 g cable version	95 g M12 connector version

CONNECTIONS

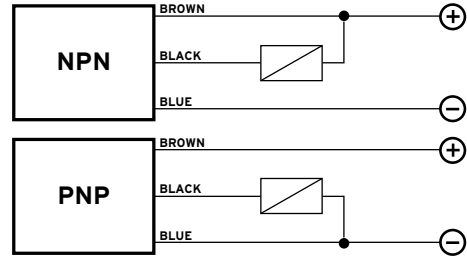

M12 CONNECTOR

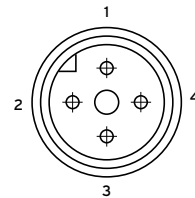

View of
quadripole
male
connector

CONFIGURATION

Outputs	PIN numbers			
	1	2	3	4
(NO or NC)	+		-	NO/NC

DIMENSIONS (mm)

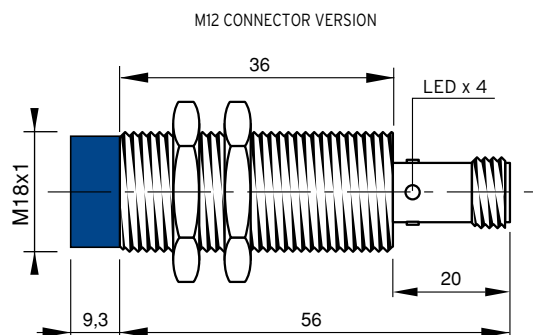
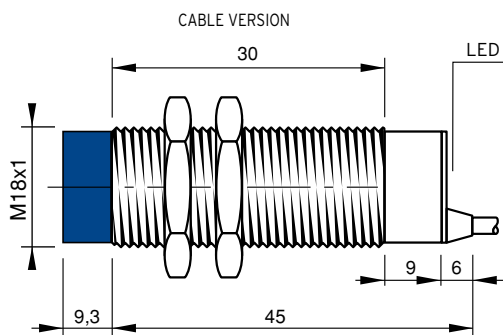

Note: the front part in blue is valid only for unshielded models



MODEL SELECTION TABLE

DIAMETER	CONSTRUCTION	OUTPUT	CONNECTION
04 = 4 mm	A= shielded standard housing	1 = 10-30 Vdc PNP NO	02 = 500 mm CABLE
05 = 5 mm	B= shielded short housing	2 = 10-30 Vdc PNP NC	03 = 2 m CABLE
08 = 8 mm	C= unshielded standard housing	3 = 10-30 Vdc NPN NO	S1 = M8 CONN.
12 = 12 mm	D= unshielded short housing	4 = 10-30 Vdc NPN NC	S2 = M12 CONN.
18 = 18 mm	E= shielded standard housing, double operating distance	5 = 10-30 Vdc PNP NO-NC	
30 = 30 mm	F= unshielded standard housing, double operating distance	6 = 10-30 Vdc NPN NO-NC	
	G= shielded short housing, double operating distance	7 = 24-230 Vac - 2 wires NO	
	H= unshielded short housing, double operating distance	8 = 24-230 Vac - 2 wires NC	
	I= shielded standard metal housing	9 = 10-30 Vac - 2 wires NO-NC	
	L= unshielded standard metal housing	0 = 12-30 Vac - 4 wires	

PRODUCT TABLE

DESCRIPTION	CONNECTION	SHIELDED	HOUSING	ORDER CODE
IS-18-G1-03	CABLE	yes	short	95B063520
IS-18-G1-S2	M12	yes	short	95B063530
IS-18-G2-03	CABLE	yes	short	95B063540
IS-18-G2-S2	M12	yes	short	95B063550
IS-18-G3-03	CABLE	yes	short	95B063480
IS-18-G3-S2	M12	yes	short	95B063490
IS-18-G4-03	CABLE	yes	short	95B063500
IS-18-G4-S2	M12	yes	short	95B063510
IS-18-H1-03	CABLE	no	short	95B063600
IS-18-H1-S2	M12	no	short	95B063610
IS-18-H2-03	CABLE	no	short	95B063620
IS-18-H2-S2	M12	no	short	95B063630
IS-18-H3-03	CABLE	no	short	95B063560
IS-18-H3-S2	M12	no	short	95B063570
IS-18-H4-03	CABLE	no	short	95B063580
IS-18-H4-S2	M12	no	short	95B063590



INDUCTIVE SENSORS

Ø 18 DOUBLE OPERATING DISTANCE 10÷30 Vdc - 4 WIRES NPN OR PNP OUTPUT

- 8 mm to 14 mm operating distance - shielded, unshielded
- Short housing models
- 200mA NPN or PNP
- Output status LED
- Cable or M12 connector models

IS Series



TECHNICAL DATA

	SHIELDED	UNSHIELDED
OPERATING DISTANCE (Sn)	8 mm	14 mm
POWER SUPPLY	10 ÷ 30 Vdc (-15 / +10%)	
RIPPLE	≤ 10%	
HYSTERESIS	< 10%	
OUTPUT CURRENT	200 mA max.	
CONSUMPTION	< 10 mA @ 24 Vdc	
SATURATION VOLTAGE	< 1.2 V (I = 100 mA)	
INDICATORS	Yellow LED	
SWITCHING FREQUENCY	400 Hz	
DELAY AT POWER ON	≤ 75 ms	
REPEATABILITY	≤ 3%	
SHORT CIRCUIT PROTECTION	Present (self-resetting)	
PROTECTION CIRCUIT	Against polarity reversal - inductive loads	
OPERATING TEMPERATURE	- 25 ÷ +70 °C	
MECHANICAL PROTECTION	IP67	
CONNECTIONS	2 m cable (3 x 0.25 mm ²)	
HOUSING MATERIAL	Nickel-plated brass	
WEIGHT	145 g cable version	95 g M12 connector version

CONNECTIONS

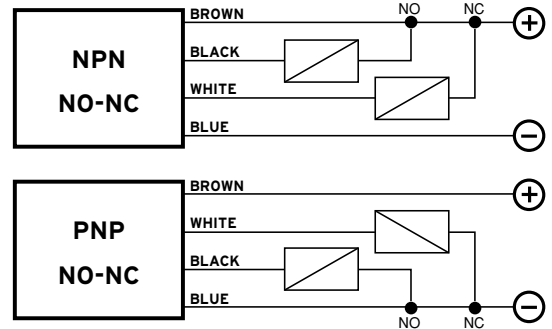

M12 CONNECTOR



View of
quadripole
male
connector

CONFIGURATION

Outputs	PIN numbers			
	1	2	3	4
(NO + NC)	+	NC	-	NO

DIMENSIONS (mm)

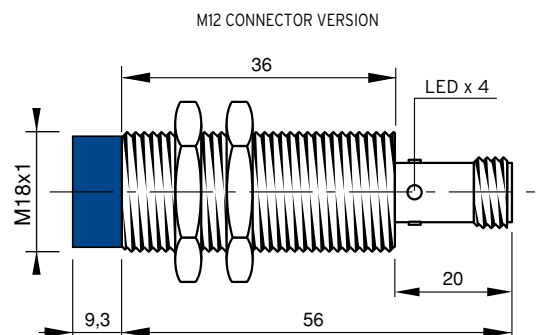
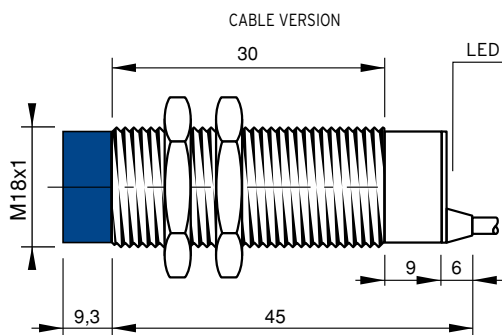

Note: the front part in blue is valid only for unshielded models



MODEL SELECTION TABLE

DIAMETER	CONSTRUCTION	OUTPUT	CONNECTION
04 = 4 mm	A= shielded standard housing	1 = 10-30 Vdc PNP NO	02 = 500 mm CABLE
05 = 5 mm	B= shielded short housing	2 = 10-30 Vdc PNP NC	03 = 2 m CABLE
08 = 8 mm	C= unshielded standard housing	3 = 10-30 Vdc NPN NO	S1 = M8 CONN.
12 = 12 mm	D= unshielded short housing	4 = 10-30 Vdc NPN NC	S2 = M12 CONN.
18 = 18 mm	E= shielded standard housing, double operating distance	5 = 10-30 Vdc PNP NO-NC	
30 = 30 mm	F= unshielded standard housing, double operating distance	6 = 10-30 Vdc NPN NO-NC	
	G= shielded short housing, double operating distance	7 = 24-230 Vac - 2 wires NO	
	H= unshielded short housing, double operating distance	8 = 24-230 Vac - 2 wires NC	
	I= shielded standard metal housing	9 = 10-30 Vac - 2 wires NO-NC	
	L= unshielded standard metal housing	0 = 12-30 Vac - 4 wires	

PRODUCT TABLE

DESCRIPTION	CONNECTION	SHIELDED	HOUSING	ORDER CODE
IS-18-G5-03	2 m CABLE	yes	standard	95B062720
IS-18-G5-S2	M12 CONNECTOR	yes	standard	95B062730
IS-18-G6-03	2 m CABLE	yes	standard	95B062700
IS-18-G6-S2	M12 CONNECTOR	yes	standard	95B062710
IS-18-H5-03	2 m CABLE	no	standard	95B062800
IS-18-H5-S2	M12 CONNECTOR	no	standard	95B062810
IS-18-H6-03	2 m CABLE	no	standard	95B062780
IS-18-H6-S2	M12 CONNECTOR	no	standard	95B062790



INDUCTIVE SENSORS

Ø 18 DOUBLE OPERATING DISTANCE 12÷30 Vdc - 4 WIRES PROGRAMMABLE OUTPUT

- 8 mm to 14 mm operating distance - shielded, unshielded
- Programmable outputs: NPN/PNP, NO or NC
- Cable models
- Nickel-plated brass
- Output status LED
- 200 mA max output

IS Series



TECHNICAL DATA

	SHIELDED	UNSHIELDED
OPERATING DISTANCE (Sn)	8 mm	14 mm
POWER SUPPLY	12 ÷ 30 Vdc (-15/+10%)	
RIPPLE	≤ 10%	
HYSTERESIS	< 10%	
OUTPUT	NPN o PNP (may be selected)	
CONTACT	NO o NC (may be selected)	
OUTPUT CURRENT	200 mA max.	
CONSUMPTION	< 1.2 mA @ 24 Vdc	
SATURATION VOLTAGE	< 1,8 V (I = 100 mA)	
INDICATORS	Yellow LED	
SWITCHING FREQUENCY	400 Hz	
DELAY AT POWER ON	≤ 50 ms	
REPEATABILITY	≤ 3%	
SHORT CIRCUIT PROTECTION	Present (self-resetting)	
PROTECTIONS CIRCUIT	Against polarity reversal - inductive loads	
OPERATING TEMPERATURE	- 25 ÷ +70 °C	
MECHANICAL PROTECTION	IP67	
CONNECTIONS	2 m cable (4 x 0.25 mm ²)	
HOUSING MATERIAL	Nickel-plated brass	
WEIGHT	145 g cable version	

⁽¹⁾ Device marking II 3D IP67 T6X.

CONNECTIONS

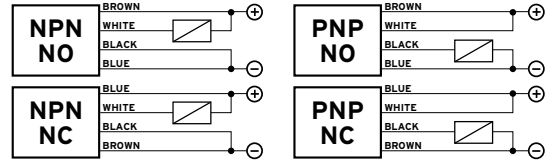

These sensors, thanks to the unpaired output circuit offer 4 output configurations (NPN-NO, NPN-NC, PNP-NO, PNP-NC) on the same model.

DIMENSIONS (mm)

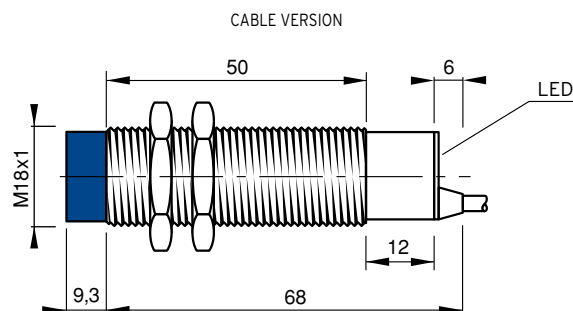

Note: the front part in blue is valid only for unshielded models



MODEL SELECTION TABLE

DIAMETER	CONSTRUCTION	OUTPUT	CONNECTION
04 = 4 mm	A= shielded standard housing	1 = 10-30 Vdc PNP NO	02 = 500 mm CABLE
05 = 5 mm	B= shielded short housing	2 = 10-30 Vdc PNP NC	03 = 2 m CABLE
08 = 8 mm	C= unshielded standard housing	3 = 10-30 Vdc NPN NO	S1 = M8 CONN.
12 = 12 mm	D= unshielded short housing	4 = 10-30 Vdc NPN NC	S2 = M12 CONN.
18 = 18 mm	E= shielded standard housing, double operating distance	5 = 10-30 Vdc PNP NO-NC	
30 = 30 mm	F= unshielded standard housing, double operating distance	6 = 10-30 Vdc NPN NO-NC	
	G= shielded short housing, double operating distance	7 = 24-230 Vac - 2 wires NO	
	H= unshielded short housing, double operating distance	8 = 24-230 Vac - 2 wires NC	
	I= shielded standard metal housing	9 = 10-30 Vac - 2 wires NO-NC	
	L= unshielded standard metal housing	0 = 12-30 Vac - 4 wires	

PRODUCT TABLE

DESCRIPTION	CONNECTION	SHIELDED	HOUSING	ORDER CODE
IS-18-E0-03	CABLE	yes	standard	95B063850



INDUCTIVE SENSORS

Ø 18 DOUBLE OPERATING DISTANCE 10÷30 Vdc - 2 WIRES NO-NC PROGRAMABLE OUTPUT

- 8 mm to 14 mm operating distance - shielded, unshielded
- Cable models
- Nickel-plated brass

IS Series



TECHNICAL DATA

	SHIELDED	UNSHIELDED
OPERATING DISTANCE (S _n)	8 mm	14 mm
POWER SUPPLY	10 ÷ 30 Vdc (-15 / +10%)	
RIPPLE	≤ 10%	
HYSTERESIS	< 10%	
OUTPUT CURRENT	100 mA max.	
OUTPUT CURRENT	> 1,6 mA min.	
INRUSH CURRENT	< 1,6 mA	
SATURATION VOLTAGE	< 6,5 V (I = 100 mA)	
INDICATORS	Yellow LED	
SWITCHING FREQUENCY	400 Hz	
DELAY AT POWER ON	≤ 50 ms	
REPEATABILITY	≤ 3%	
SHORT CIRCUIT PROTECTION	Present (self-resetting)	
PROTECTIONS CIRCUIT	Against polarity reversal - inductive loads	
OPERATING TEMPERATURE	- 25 ÷ +70 °C	
MECHANICAL PROTECTION	IP67	
CONNECTIONS	2 m cable (2 x 0.25 mm ²)	
HOUSING MATERIAL	Nickel-plated brass	
WEIGHT	145 g cable version	

CONNECTIONS

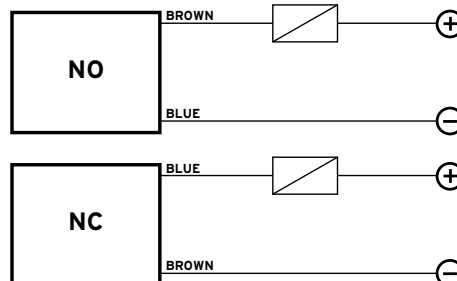

WARNING: The load can be connected in series to the blue wire or to the brown wire to simulate the NPN or PNP functioning logic.

DIMENSIONS (mm)

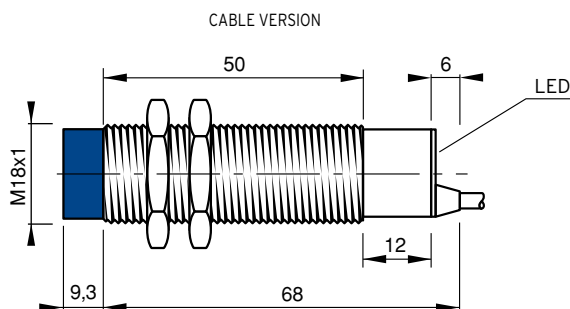

Note: the front part in blue is valid only for unshielded models



MODEL SELECTION TABLE

DIAMETER	CONSTRUCTION	OUTPUT	CONNECTION
04 = 4 mm	A= shielded standard housing	1 = 10-30 Vdc PNP NO	02 = 500 mm CABLE
05 = 5 mm	B= shielded short housing	2 = 10-30 Vdc PNP NC	03 = 2 m CABLE
08 = 8 mm	C= unshielded standard housing	3 = 10-30 Vdc NPN NO	S1 = M8 CONN.
12 = 12 mm	D= unshielded short housing	4 = 10-30 Vdc NPN NC	S2 = M12 CONN.
18 = 18 mm	E= shielded standard housing, double operating distance	5 = 10-30 Vdc PNP NO-NC	
30 = 30 mm	F= unshielded standard housing, double operating distance	6 = 10-30 Vdc NPN NO-NC	
	G= shielded short housing, double operating distance	7 = 24-230 Vac - 2 wires NO	
	H= unshielded short housing, double operating distance	8 = 24-230 Vac - 2 wires NC	
	I= shielded standard metal housing	9 = 10-30 Vac - 2 wires NO-NC	
	L= unshielded standard metal housing	0 = 12-30 Vac - 4 wires	

PRODUCT TABLE

DESCRIPTION	CONNECTION	SHIELDED	HOUSING	ORDER CODE
IS-18-E9-03	CABLE	yes	standard	95B063810



INDUCTIVE SENSORS

Ø 18

24 ÷ 230 Vac - 2 WIRES NO OR NC OUTPUT

- 5 mm to 8 mm operating distance - shielded, unshielded
- Cable or M12 connector models
- Very low consumption < 0,7 mA
- Inrush current (20ms) 1.5A
- 300mA max output

IS Series



TECHNICAL DATA

	SHIELDED	UNSHIELDED
OPERATING DISTANCE (Sn)	5 mm	8 mm
POWER SUPPLY	24 ÷ 230 Vac (-15/+10%)	
NET FREQUENCY	50 ÷ 60 Hz	
HYSTERESIS	< 10%	
OUTPUT CURRENT	300 mA max.	
OUTPUT CURRENT	20 mA min.	
INRUSH CURRENT	1,5 A max. (20 ms)	
RESIDUAL CURRENT	< 0,7 mA	
SATURATION VOLTAGE	< 5 V (I = 100 mA)	
INDICATORS	Yellow LED	
SWITCHING FREQUENCY	12 Hz	
DELAY AT POWER ON	≤ 300 ms	
REPEATABILITY	≤ 3%	
OPERATING TEMPERATURE	-25 ÷ +70 °C	
MECHANICAL PROTECTION	IP67	
CONNECTIONS	2 m cable (2 x 0.25 mm ²)	
HOUSING MATERIAL	Nickel-plated brass	
WEIGHT	145 g cable version	
	95 g M12 connector cable	

CONNECTIONS

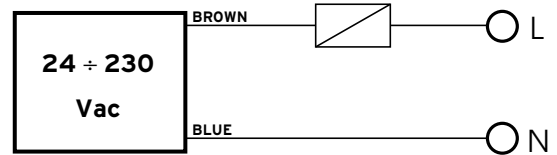

Warning: Output short circuit are not possible. Wrong supply cable connections can damage the sensor. Therefore sensors whose output status is short-circuited will not be replaced under warranty.

M12 CONNECTOR

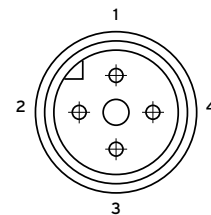

View of quadripole male connector.

CONFIGURATION

Outputs	PIN numbers			
	1	2	3	4
(NO or NC)	L		N	

DIMENSIONS (mm)

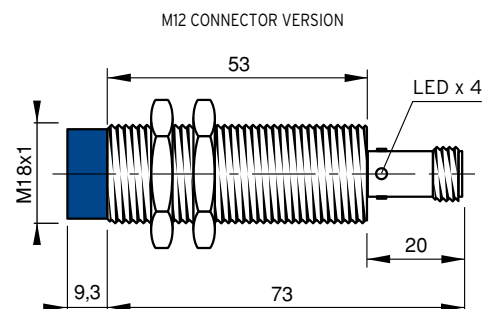
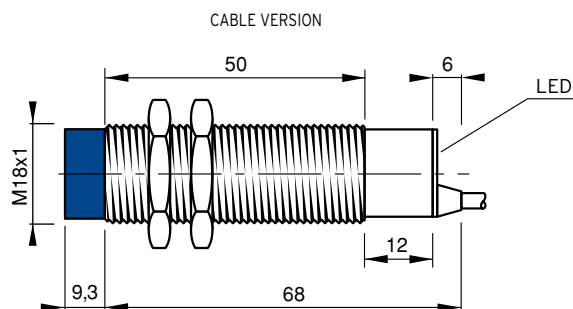

Note: the front part in blue is valid only for unshielded models



MODEL SELECTION TABLE

DIAMETER	CONSTRUCTION	OUTPUT	CONNECTION
04 = 4 mm	A= shielded standard housing	1 = 10-30 Vdc PNP NO	02 = 500 mm CABLE
05 = 5 mm	B= shielded short housing	2 = 10-30 Vdc PNP NC	03 = 2 m CABLE
08 = 8 mm	C= unshielded standard housing	3 = 10-30 Vdc NPN NO	S1 = M8 CONN.
12 = 12 mm	D= unshielded short housing	4 = 10-30 Vdc NPN NC	S2 = M12 CONN.
18 = 18 mm	E= shielded standard housing, double operating distance	5 = 10-30 Vdc PNP NO-NC	
30 = 30 mm	F= unshielded standard housing, double operating distance	6 = 10-30 Vdc NPN NO-NC	
	G= shielded short housing, double operating distance	7 = 24-230 Vac - 2 wires NO	
	H= unshielded short housing, double operating distance	8 = 24-230 Vac - 2 wires NC	
	I= shielded standard metal housing	9 = 10-30 Vac - 2 wires NO-NC	
	L= unshielded standard metal housing	0 = 12-30 Vac - 4 wires	

PRODUCT TABLE

DESCRIPTION	CONNECTION	SHIELDED	HOUSING	ORDER CODE
IS-18-A7-03	2 m CABLE	yes	standard	95B062860
IS-18-A7-S2	M12 CONNECTOR	yes	standard	95B062870
IS-18-A8-03	2 m CABLE	yes	standard	95B062880
IS-18-A8-S2	M12 CONNECTOR	yes	standard	95B062890
IS-18-C7-03	2 m CABLE	no	standard	95B062980
IS-18-C7-S2	M12 CONNECTOR	no	standard	95B062990
IS-18-C8-03	2 m CABLE	no	standard	95B063000
IS-18-C8-S2	M12 CONNECTOR	no	standard	95B063010



INDUCTIVE SENSORS

Ø 18 DOUBLE OPERATING DISTANCE 24÷230 Vac/dc - 2 WIRES NO OR NC OUTPUT

- 8 mm to 14 mm operating distance - shielded, unshielded
- Short circuit protection AC/DC
- Cable models
- Inrush current (20ms) 2.5A
- 350mA max output

IS Series



TECHNICAL DATA

	SHIELDED	UNSHIELDED
OPERATING DISTANCE (Sn)	8 mm	14 mm
POWER SUPPLY	24 ÷ 230 Vac/dc (-15/+10%)	
NET FREQUENCY	50 ÷ 60 Hz	
HYSTERESIS	< 10%	
OUTPUT CURRENT	350 mA max.	
OUTPUT CURRENT	4 mA min.	
INRUSH CURRENT	2,5 A max. (20 ms)	
RESIDUAL CURRENT	< 1,5 mA	
SATURATION VOLTAGE	< 6 V (I=100 mA)	
INDICATORS	Yellow LED	
SWITCHING FREQUENCY	12 Hz	
DELAY AT POWER ON	≤ 300 ms	
SHORT CIRCUIT PROTECTION	Present (manual resetting)	
REPEATABILITY	≤ 3%	
OPERATING TEMPERATURE	-25 ÷ +70 °C	
MECHANICAL PROTECTION	IP67	
CONNECTIONS	2 m cable (2 x 0.25 mm ²)	
HOUSING MATERIAL	Nickel-plated brass	
WEIGHT	145 g cable version	

CONNECTIONS

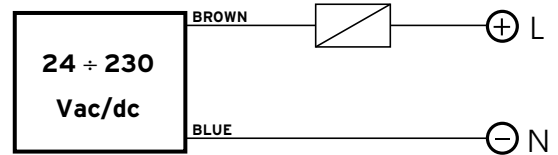

DIMENSIONS (mm)

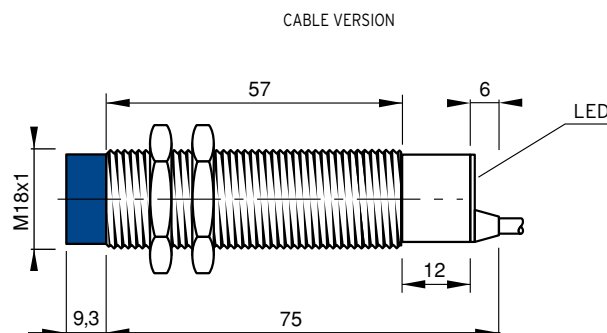

Note: the front part in blue is valid only for unshielded models



MODEL SELECTION TABLE

DIAMETER	CONSTRUCTION	OUTPUT	CONNECTION
04 = 4 mm	A= shielded standard housing	1 = 10-30 Vdc PNP NO	02 = 500 mm CABLE
05 = 5 mm	B= shielded short housing	2 = 10-30 Vdc PNP NC	03 = 2 m CABLE
08 = 8 mm	C= unshielded standard housing	3 = 10-30 Vdc NPN NO	S1 = M8 CONN.
12 = 12 mm	D= unshielded short housing	4 = 10-30 Vdc NPN NC	S2 = M12 CONN.
18 = 18 mm	E= shielded standard housing, double operating distance	5 = 10-30 Vdc PNP NO-NC	
30 = 30 mm	F= unshielded standard housing, double operating distance	6 = 10-30 Vdc NPN NO-NC	
	G= shielded short housing, double operating distance	7 = 24-230 Vac - 2 wires NO	
	H= unshielded short housing, double operating distance	8 = 24-230 Vac - 2 wires NC	
	I= shielded standard metal housing	9 = 10-30 Vac - 2 wires NO-NC	
	L= unshielded standard metal housing	0 = 12-30 Vac - 4 wires	

PRODUCT TABLE

DESCRIPTION	CONNECTION	SHIELDED	HOUSING	ORDER CODE
IS-18-E7-03	CABLE	yes	standard	95B063900

INDUCTIVE SENSORS

Ø 18

10÷30 Vdc - 3 WIRES PNP OUTPUT

- 5 mm to 8 mm operating distance - shielded, unshielded
- Stainless steel housing
- Cable or M12 connector models
- Output status LED

IS Series



TECHNICAL DATA

	SHIELDED	UNSHIELDED
OPERATING DISTANCE (Sn)	5 mm	8 mm
POWER SUPPLY	10 ÷ 30 Vdc (-15 / +10%)	
RIPPLE	≤ 10%	
HYSTERESIS	< 15%	
OUTPUT CURRENT	200 mA max.	
RESIDUAL CURRENT	< 10 mA	
SATURATION VOLTAGE	< 1.5 V (I = 100 mA)	
INDICATORS	Yellow LED	
SWITCHING FREQUENCY	1000 Hz	500 Hz
REPEATABILITY	≤ 1%	
SHORT CIRCUIT PROTECTION	Present (self-resetting)	
OPERATING TEMPERATURE	- 25 ÷ +70 °C	
MECHANICAL PROTECTION	IP67	
ACTIVE FACE MATERIAL	Stainless steel	
HOUSING MATERIAL	Stainless steel	
WEIGHT	95 g cable version	

CONNECTIONS

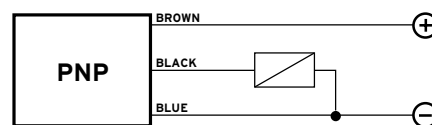

M12 CONNECTOR

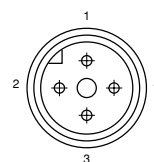

View of quadripole male connector.

CONFIGURATION

Outputs	PIN numbers			
	1	2	3	4
NO	+		-	NO

DIMENSIONS (mm)

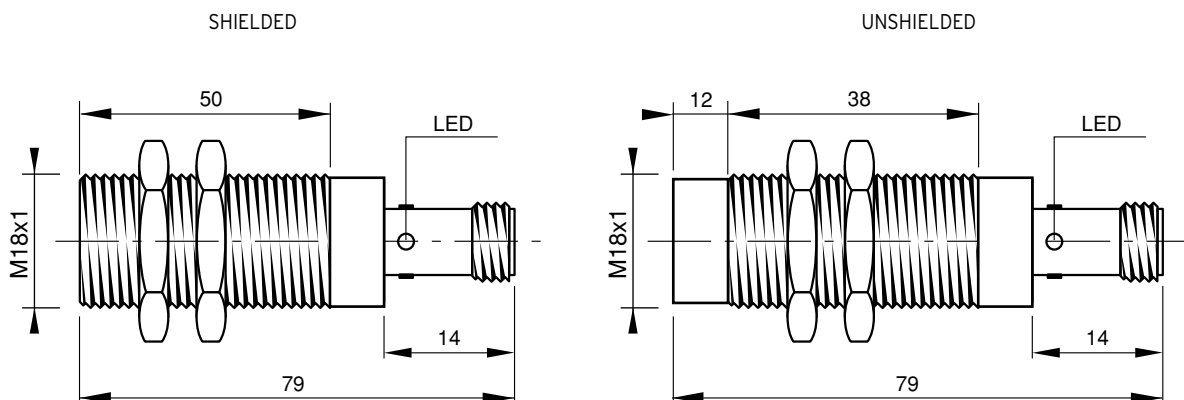



MODEL SELECTION TABLE

DIAMETER	CONSTRUCTION	OUTPUT	CONNECTION
04 = 4 mm	A= shielded standard housing	1 = 10-30 Vdc PNP NO	02 = 500 mm CABLE
05 = 5 mm	B= shielded short housing	2 = 10-30 Vdc PNP NC	03 = 2 m CABLE
08 = 8 mm	C= unshielded standard housing	3 = 10-30 Vdc NPN NO	S1 = M8 CONN.
12 = 12 mm	D= unshielded short housing	4 = 10-30 Vdc NPN NC	S2 = M12 CONN.
18 = 18 mm	E= shielded standard housing, double operating distance	5 = 10-30 Vdc PNP NO-NC	
30 = 30 mm	F= unshielded standard housing, double operating distance	6 = 10-30 Vdc NPN NO-NC	
	G= shielded short housing, double operating distance	7 = 24-230 Vac - 2 wires NO	
	H= unshielded short housing, double operating distance	8 = 24-230 Vac - 2 wires NC	
	I= shielded standard metal housing	9 = 10-30 Vac - 2 wires NO-NC	
	L= unshielded standard metal housing	0 = 12-30 Vac - 4 wires	

PRODUCT TABLE

DESCRIPTION	CONNECTION	SHIELDED	HOUSING	ORDER CODE
IS-18-L5-S2	M12	no	standard	95B063880