

Silencer

AN□00/AN□02/AN□03/25/AN

Standard

Series AN□00

Over 30dB(A) noise reduction
Low back pressure
Compact and easy mounting

JIS symbol

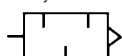

Specifications

Fluid	Compressed air
Max.operating pressure	1.0MPa
Noise reduction	30dB(A) or more
Ambient and fluid temperature	5 to 60°C*

* It can operate in temperatures between -10 to 60°C if there is no risk of the moisture in the air freezing.

Model

Model	Port size R(PT)	Effective area (mm ²)	Weight (g)	Dimensions (mm)		
				A	B	D
AN200-02	1/4	35	17	63	22	19
AN300-03	3/8	60	25	84	25	22
AN400-04	1/2	90	35	92	30	27
AN500-06	3/4	160	165	107	46	36
AN600-10	1	270	225	132	50	41
AN700-12	1 1/4	440	490	200	74	55
AN800-14	1 1/2	590	580	233	74	60
AN900-20	2	960	820	263	86	70

Note) NPT thread is also available. Specify "N" after "AN□00-".
(Ex.: AN200-N02)

Construction/Parts/Dimensions AN200 to 400

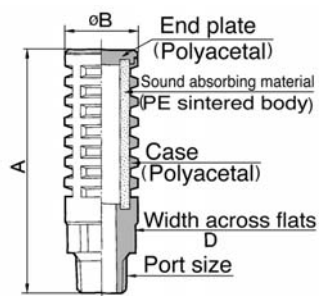

AN500 to 900

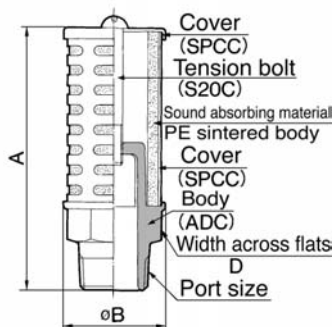

High noise reduction style

Series AN□02

Over 35dB(A) noise reduction
Case is UL94-V0 Grade
Flame resistance material

JIS symbol

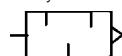

Specifications

Fluid	Compressed air
Max.operating pressure	1.0MPa
Noise reduction	35dB(A) or more
Ambient and fluid temperature	5 to 60°C*

* It can operate in temperatures between -10 to 60°C if there is no risk of the moisture in the air freezing.

Model

Model	Port size R(PT)	Effective area (mm ²)	Weight (g)	Dimensions (mm)		
				A	B	D
AN202-02	1/4	35	16	64	22	19
AN302-03	3/8	60	33	84	28	24
AN402-04	1/2	90	47	95	34	24

Note) NPT thread is also available. Specify "N" after "AN□02-".
(Ex.: AN200-N02)

Construction/Parts/Dimensions AN202

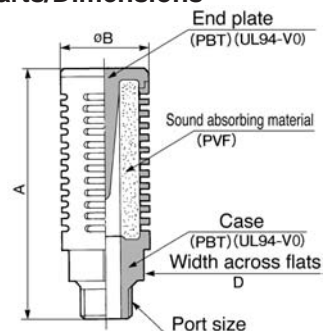

AN302/402

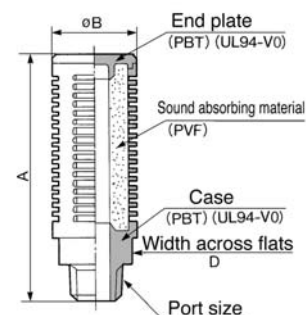

AN□00/AN□02/AN□03/25/AN

Compact style Series AN□03

Over 25dB(A) noise reduction
Space saving
Compact style

JIS symbol

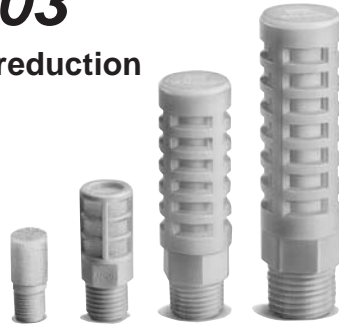
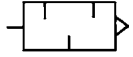

Specifications

Operating fluid	Compressed air
Max. operating pressure	1.0MPa
Noise reduction	25dB(A) or more
Ambient and fluid temperature	5 to 60°C*

* It can operate in temperatures between -10 to 60°C if there is no risk of the moisture in the air freezing.

Model

Model	Port size R(PT)	Effective area (mm ²)	Weight (g)	Dimensions (mm)		
				A	B	D
AN103-01	1/8	10	1	23.5	11	—
AN203-02	1/4	15	3	36	16	14
AN303-03	3/8	35	17	66	22	19
AN403-04	1/2	60	25	84	25	22

Note) NPT thread is also available. Specify "N" after "AN□03-".
(Ex.: AN103-N01)

Metal case style Series 25

Exhaust in only one direction.
Prevents scattering of mist and noise.

JIS symbol

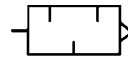

Specifications

Operating fluid	Compressed air
Max. operating pressure	1.0MPa
Noise reduction	19dB(A) or more
Ambient and fluid temperature	5 to 60°C*

* It can operate in temperatures between -10 to 60°C if there is no risk of the moisture in the air freezing.

Model

Model	Port size R(PT)	Effective area (mm ²)	Weight (g)	Dimensions (mm)		
				A	B	D
2504-002	1/4	33.9	111	62	30	24
2505-003	3/8	45.9	106	64	30	24
2506-004	1/2	50.0	113	68	30	24
2507-006	3/4	105.6	310	88.5	48	35
2508-010	1	129.6	514	97.5	60	41
2510-002	1/4	17.2	57	54	22	19
2511-003	3/8	17.2	55	56	22	19

Note) NPT thread is also available. Specify "N" after "25□□-".
(Ex.: 2504-N002)

Construction/Parts/Dimensions AN103 AN203

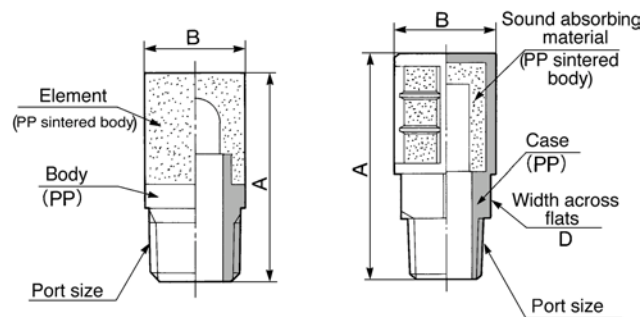

AN303/403

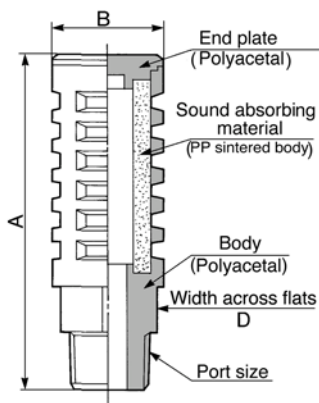

Construction/Parts/Dimensions

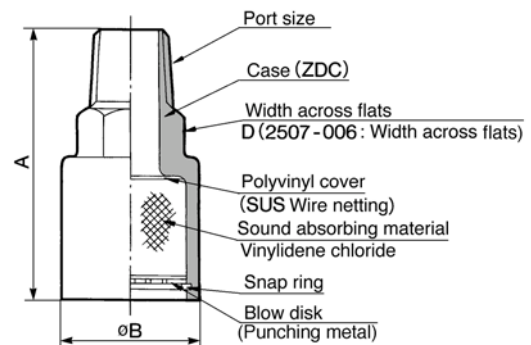

VEX

AN

AMC

AMP

AN□00/AN□02/AN□03/25/AN

Flow Characteristics (Initial conditions)

AN200 to 900

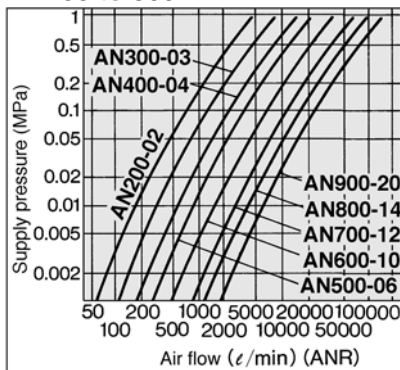

AN202 to 402

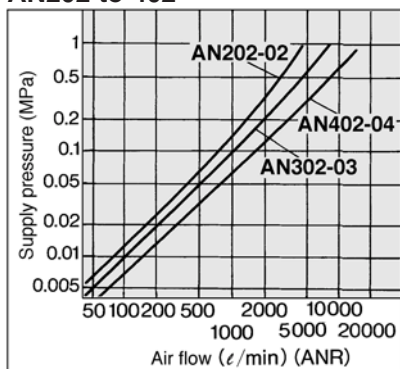

AN103 to 403

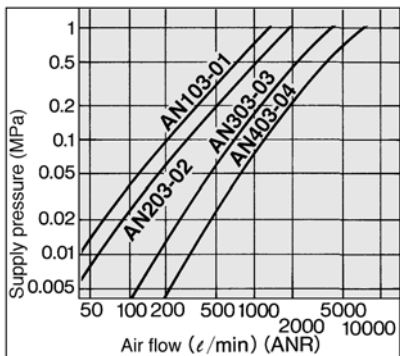

2504 to 2511

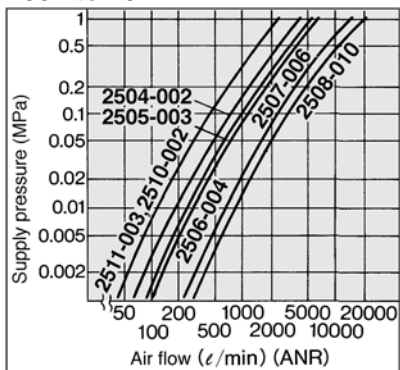

Noise Level (Initial conditions)

AN200 to 900

Condition: 0.5MPa at supply pressure of solenoid valve
Measurement distance: AN200 to 500→1m AN600 to 700→2m
AN800 to 900→3m

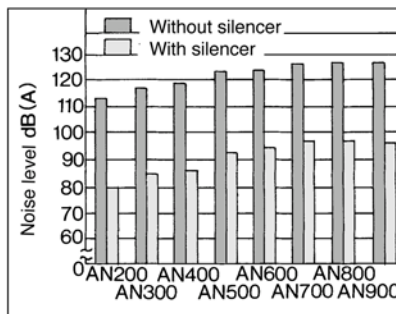

AN202 to 402

Condition: 0.5MPa at supply pressure of solenoid valve
Measurement distance: 1m

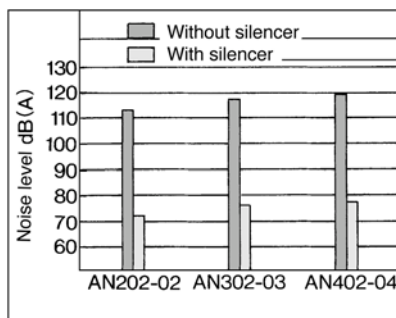

AN103 to 403

Condition: 0.5MPa at supply pressure of solenoid valve
Measurement distance: 1m

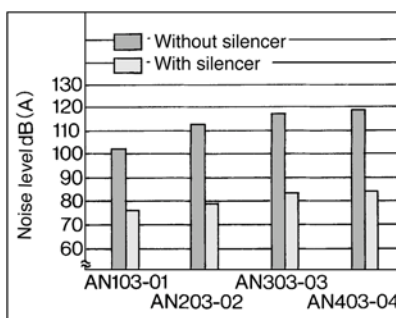

2504 to 2511

Condition: 0.5MPa at supply pressure of solenoid valve
Measurement distance: 1m

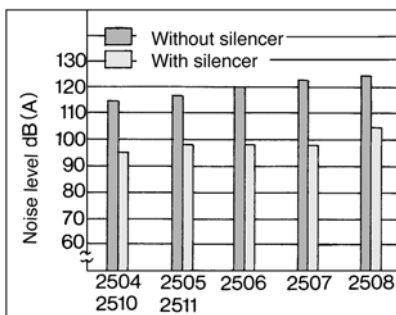

(BC Sintered Body) Series AN

Ideal for the exhaust of a compact valve or pilot air.

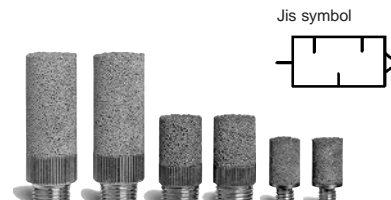

Specifications/Model

Model	AN101	AN110	AN120	AN120
Specifications	-01	-01	-M3	-M5
Port size	R(PT) 1/8	R(PT) 1/8	M3	M5
Noise reduction dB(A)	16	21	13	18
Fluid	Compressed air			
Max. operating press	1.0MPa			
Ambient and fluid temperature	5 to 50°C*			
Effective area (mm ²)	20	35	1	5
Weight (g)	9.5	20	1	3.3
Dimensions (mm)	A	22.5	38	9
	B	11	13	6

Note) NPT thread for AN101 and AN110 is also available. Model no. of NPT thread is AN101-N01 and AN110-N01.

* It can operate in temperatures between -10° to 150°C if there is no risk of the moisture in the air freezing.

Construction/Parts/Dimensions

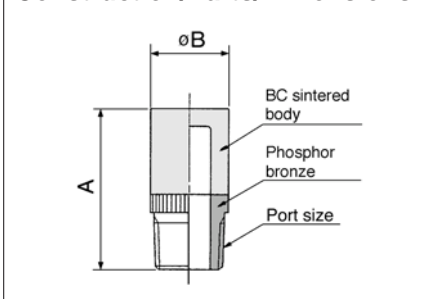

One-touch Fitting Connection Style

Series AN□□□-KM□□

Can connect with One-touch fitting directly

JIS symbol

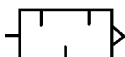

Specifications

Fluid	Compressed air
Max. operating pressure	1.0MPa
Ambient and fluid temperature	5 to 60°C

Model

Model	Applicable One-touch fitting size	Noise reduction dB(A)	Effective area (mm ²)	Dimensions (mm)		
				A	B	C
AN103-KM6	ø6 (Series KQ)	25	7	37	11	15
AN103-X233	ø6 (Series KQ)					
AN103-X235	ø1/4" (Series KQ)					
AN203-KM8	ø8 (Series KQ)	30	20	78	22	54
AN200-KM8	ø8 (Series KQ)					
AN200-KM10	ø10 (Series KQ)					
AN300-KM10	ø10 (Series KQ)					
AN300-KM12	ø12 (Series KQ)					

Construction/Parts/Dimensions

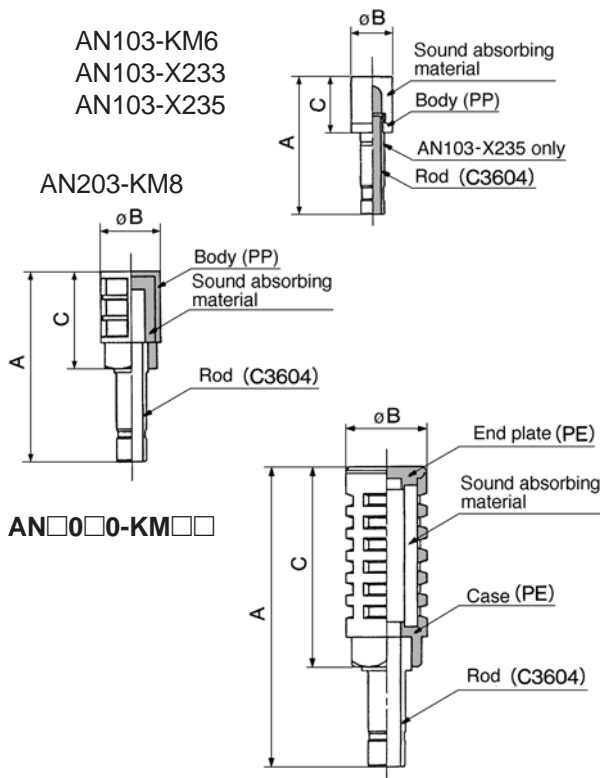

⚠ Precautions

Be sure to read before handling. Refer to p.0-33 to 0-36 for Safety Instructions and common precautions.

Design

⚠ Warning

① The exhaust port could become blocked by the clogging of the silencer. Therefore, make sure to provide a safe design so as not to cause the system as a whole to malfunction.

⚠ Caution

① The silencing effect could vary depending on the pneumatic circuit or the pressure that is used.

Mounting

⚠ Caution

- ① If the silencer body (case) is made of plastic and is BC sintered: To mount on a valve, hold the end of the body (the side that is not threaded) with your fingers and screw it in. After some resistance is felt, use a wrench that matches the wrench flats of the hexagon portion to tighten it an additional 1/4 turn. (If the silencer is not provided with a hexagon portion, manually tighten it firmly.)
- ② If the silencer body is made of metal (except the BC sintered style), tighten it at the torque given below.

Connection thread	Applicable tightening torque (Nm)
Rc(PT) 1/4	12 to 14
Rc(PT) 3/8	22 to 24
Rc(PT) 1/2	28 to 30
Rc(PT) 3/4	28 to 30
Rc(PT)1	36 to 38
Rc(PT)1 1/4	40 to 42
Rc(PT)1 1/2	48 to 50
Rc(PT)2	48 to 50

③ Make sure not to apply a lateral load to the body during or after the installation.

Maintenance/Inspection

⚠ Caution

- ① Never disassemble the silencer. The silencing material is not replaceable.
- ② If the exhaust speed drops and the system performance decreases due to clogging, replace with a new silencer. Make sure to verify the operating conditions of the actuator at least once a day.

VEX

AN

AMC

AMP